

Features

- Epoxy meets UL 94 V-0 flammability rating
- Small outline surface mount package
- Low current leakage
- For high-speed switching applications

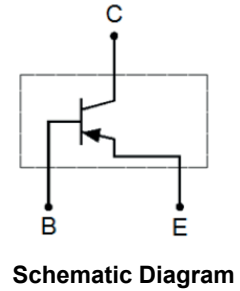
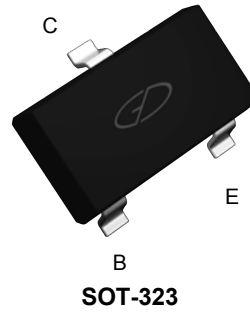

Maximum Ratings ($T_A=25^{\circ}\text{C}$ unless otherwise specified)

Parameter	Symbol	Value	Unit
Collector-Base Voltage	V_{CB0}	-80	V
Collector-Emitter Voltage	V_{CEO}	-65	V
Emitter-Base Voltage	V_{EBO}	-5	V
Power Dissipation	I_C	-100	mA
Collector Power Dissipation	P_C	150	mW
Thermal Resistance from Junction to Ambient	$R_{\theta JA}$	833	$^{\circ}\text{C}/\text{W}$
Junction Temperature	T_J	150	$^{\circ}\text{C}$
Storage Temperature	T_{stg}	-55 to +150	$^{\circ}\text{C}$

Electrical Characteristics ($T_A=25^{\circ}\text{C}$ unless otherwise specified)

Parameter	Symbol	Test Conditions	Min	Typ	Max	Units
Collector-Base Breakdown Voltage	V_{CB0}	$I_C=-10\mu\text{A}, I_E=0$	-80	-	-	V
Collector-Emitter Breakdown Voltage	V_{CEO}	$I_C=-10\text{mA}, I_B=0$	-65	-	-	V
Emitter-Base Breakdown Voltage	V_{EBO}	$I_E=-1\mu\text{A}, I_C=0$	-5	-	-	V
Collector Cut-Off Current	I_{CBO}	$V_{CB}=-30\text{V}, I_E=0$	-	-	-15	nA
DC Current Gain	GSBC856AW	$V_{CE}=-5\text{V}, I_C=-2\text{mA}$	125	-	250	-
	GSBC856BW		220	-	475	
Collector-Emitter Saturation Voltage	$V_{CE(sat)}$	$I_C=-100\text{mA}, I_B=-5\text{mA}$	-	-	-0.65	V
Base-Emitter Saturation Voltage	$V_{BE(sat)}$	$I_C=-100\text{mA}, I_B=-5\text{mA}$	-	-	-1.1	V
Transition Frequency	f_T	$V_{CE}=-5\text{V}, I_C=-10\text{mA}, F=100\text{MHz}$	100	-	-	MHz
Collector Output Capacitance	C_{ob}	$V_{CB}=-10\text{V}, F=1\text{MHz}$	-	4.5	-	pF

Typical Characteristic Curves

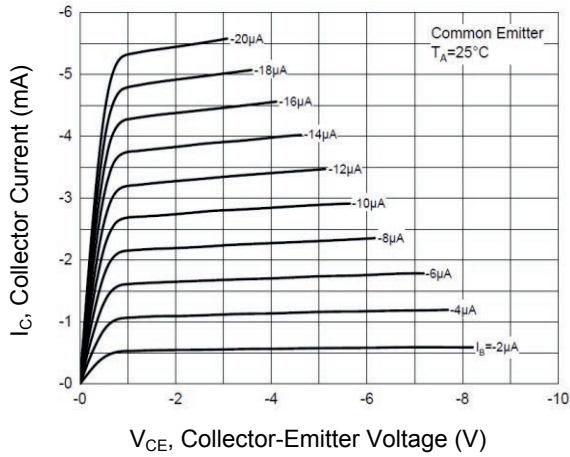

Figure 1. Static Characteristic

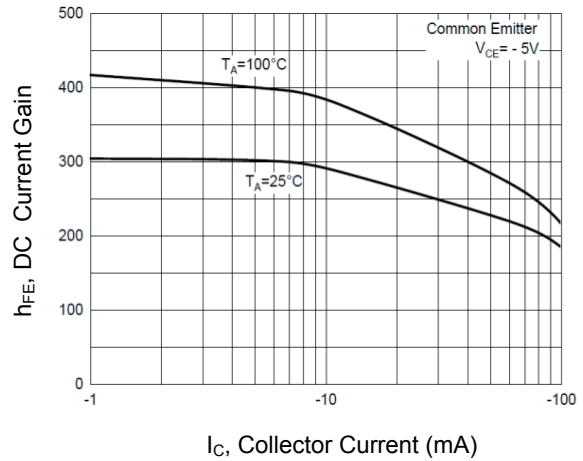

Figure 2. DC Current Gain Characteristics

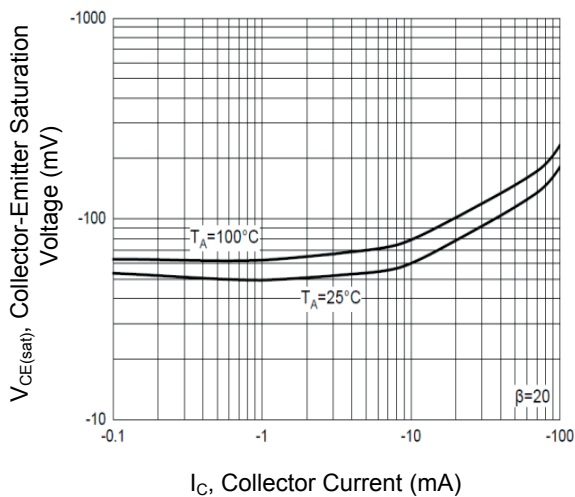

Figure 3. Collector-Emitter Saturation Voltage Characteristics

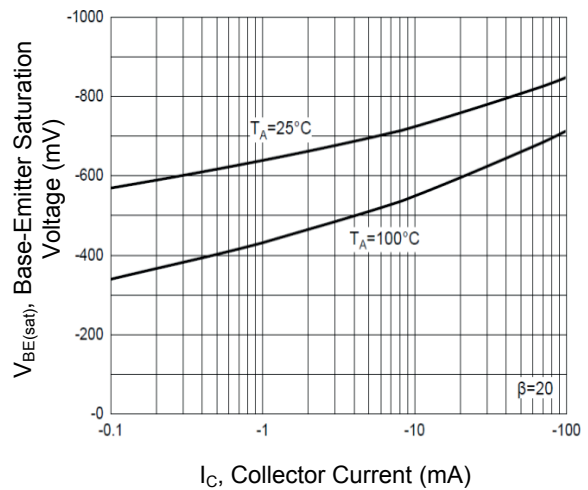

Figure 4. Base-Emitter Saturation Voltage Characteristics

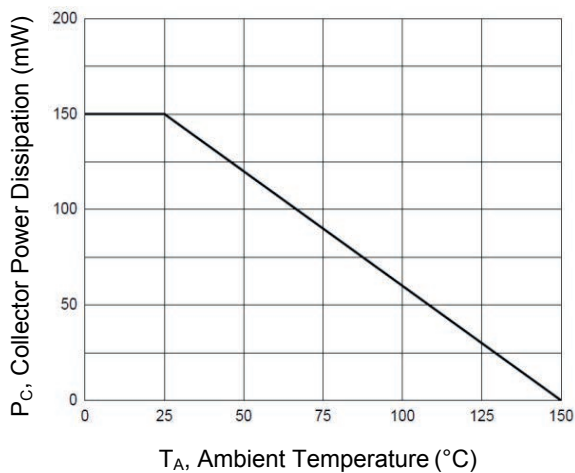
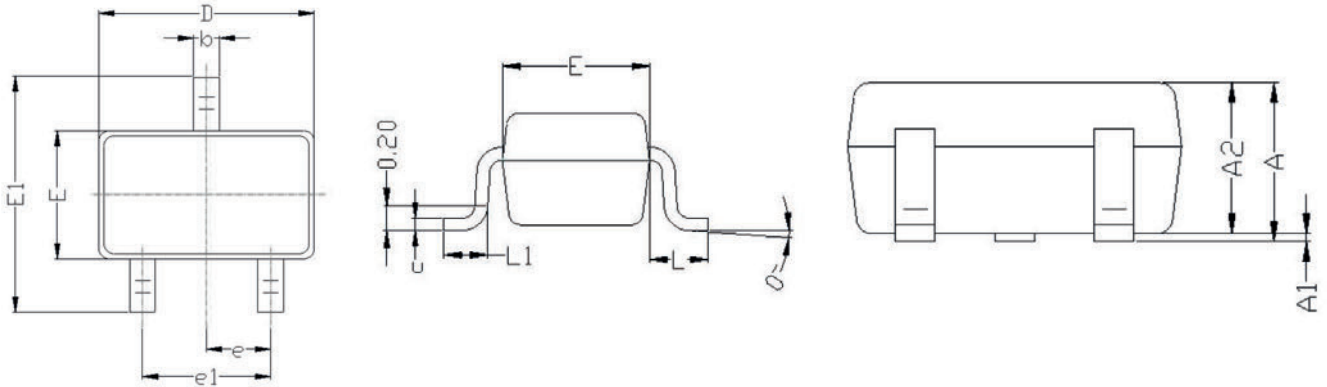

Figure 5. Collector Power Derating Curve

Package Outline Dimensions (SOT-323)



Symbol	Dimensions In Millimeters		Dimensions In Inches	
	Min.	Max.	Min.	Max.
A	0.90	1.00	0.035	0.039
A1	0.00	0.10	0.000	0.004
A2	0.90	1.00	0.035	0.039
b	0.20	0.40	0.008	0.016
C	0.08	0.15	0.003	0.006
D	2.00	2.20	0.079	0.087
E	1.15	1.35	0.045	0.053
E1	2.15	2.45	0.085	0.096
e	0.650 TYP		0.026 TYP	
e1	1.20	1.40	0.047	0.055
L	0.525 REF		0.021 REF	
L1	0.26	0.46	0.010	0.018
θ	0°	8°	0°	8°

Recommended Pad Layout

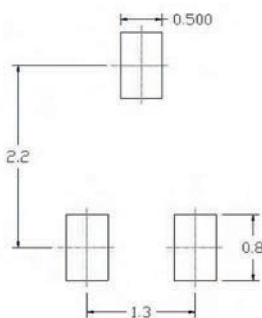

Note:

1. Controlling dimension: in millimeters
2. General tolerance: $\pm 0.05\text{mm}$
3. The pad layout is for reference purposes only

Order Information

Device	Package	Marking	Quantity	HSF Status
GSBC856AW	SOT-323	3A	3,000pcs / Reel	RoHS Compliant
GSBC856BW	SOT-323	3B	3,000pcs / Reel	RoHS Compliant